

frontrow™
symbio



USER GUIDE

5201R Receiver

940TM Pendant Transmitter

950H Pass-Around Microphone

Contents

Important Safety Instructions	1
Electrical Warnings	2
Introduction	3
Basic System Guidelines.	4
Chapter 1 Receiver Components.	5
Chapter 2 Microphone Components.	6
940™ Pendant Microphone	
Chapter 3 Features.	7
Chapter 4 Installing Batteries and Charging.	8 - 10
Chapter 5 Using	11
950H Pass-Around Microphone	
Chapter 6 Features.	12
Chapter 7 Setting gain, channel, installing battery, and charging	13 - 14
Chapter 8 Using	15 - 16
Chapter 9 Using a Second Microphone	17
950C Microphone Charger	
Chapter 10 Features.	18
Chapter 11 950C Charger Setup	19
5201R Symbio Receiver	
Chapter 12 Features.	20
Chapter 13 Activate Receiver and Transmitter	21
Chapter 14 Product Specifications.	22
Chapter 15 Troubleshooting.	23
Chapter 16 Regulatory.	24

IMPORTANT SAFETY INSTRUCTIONS

1. The apparatus shall not be exposed to dripping or splashing and no objects filled with liquids, such as vases, shall be placed on the apparatus.
2. Read these instructions.
3. Keep these instructions.
4. Heed all warnings.
5. Follow all instructions.
6. Do not use this apparatus near water.
7. Clean only with dry cloth.
8. Do not block any ventilation openings. Install in accordance with the manufacturer's instructions.
9. Do not install near any heat sources such as radiators, heat registers, stoves, or other apparatus (including amplifiers) that produce heat.
10. Do not defeat the safety purpose of the polarized or grounding-type plug. A polarized plug has two blades with one wider than the other. A grounding type plug has two blades and a third grounding prong. The wide blade or the third prong are provided for your safety. If the provided plug does not fit into your outlet, consult an electrician for replacement of the obsolete outlet.
11. Protect the power cord from being walked on or pinched particularly at plugs, convenience receptacles, and the point where they exit from the apparatus.
12. Only use attachments/accessories specified by the manufacturer.
13. Use only with the cart, stand, tripod, bracket, or table specified by the manufacturer, or sold with the apparatus. When a cart is used, use caution when moving the cart/apparatus combination to avoid injury from tip-over.



14. Unplug this apparatus during lightning storms or when unused for long periods of time.
15. Refer all servicing to qualified service personnel. Servicing is required when the apparatus has been damaged in any way, such as power-supply cord or plug is damaged, liquid has been spilled or objects have fallen into the apparatus, the apparatus has been exposed to rain or moisture, does not operate normally, or has been dropped.

WARNING

To reduce the risk of fire or electric shock, do not expose this apparatus to rain or moisture.

WARNING

To prevent injury, this apparatus must be securely attached to the floor/wall in accordance with the installation instructions.

WARNING

Batteries (battery pack or batteries installed) shall not be exposed to excessive heat such as sunshine, fire or the like. Do not use noticeably damaged batteries.

CAUTION

To reduce the risk of fire or electric shock, do not perform any servicing other than that contained in the operating instructions unless you are qualified to do so.

ELECTRICAL WARNINGS

1. Avoid Abuse to the Power Supply

To reduce risk of electric shock, unplug the power supply from outlet before attempting any maintenance or cleaning. Turn off controls will not reduce this risk.

To reduce the risk of fire or electric shock, do not expose this apparatus to rain or moisture.

DO NOT disassemble the power supply. Return the apparatus to Phonic Ear FrontRow for qualified service and repair if service or repair is required. Incorrect reassembly may result in a risk of electric shock or fire.

DO NOT expose the power supply to rain, snow, water, gas, oil, etc.

DO NOT operate the power supply if it has received a sharp blow, been dropped, or otherwise damaged in any way; return the apparatus to Phonic Ear FrontRow for qualified service and repair.

DO NOT block or cover the apparatus and impede ventilation.

DO NOT expose batteries (battery pack or batteries installed) to excessive heat such as sunshine, fire, or the like.

2. Proper Use of the Power Supply and Wiring

An extension cord should not be used unless absolutely necessary. Use of improper extension cord could result in a risk of fire and electric shock. The cord **MUST** be plugged into a grounded outlet. Make sure it is properly wired, in good electrical condition, and wire size is large enough for AC ampere rating of the power supply or charger as specified below. AWG = American Wire Gauge.

To reduce risk of damage to plug and cord when disconnecting the power supply or charger, **ALWAYS** pull on plug - **NEVER** on cord.

Locate cord so that it will not be stepped on, tripped over, or otherwise subject to damage or stress. **DO NOT** lay extension cord on charger.

DO NOT operate the power supply with damaged cord or plug - replace them immediately.

ELECTRICAL SAFETY INFORMATION:



PRECAUTIONS & SAFETY RECOMMENDATIONS

Follow Manufacturers' Recommendations

Before using the receiver and power supply, read all instructions for, and caution markings on the receiver and power supply and in this user guide.

Introduction

Congratulations on the purchase of your new FrontRow system!

FrontRow systems engage students, improve attentiveness to the teacher, build learning success, reduce the achievement gap, foster control and orderliness, improve test scores, and reduce vocal strain and fatigue for teachers. Numerous studies show that classrooms using teacher voice amplification enjoy better student comprehension, increased student participation, better grades and fewer behavioral referrals.

Read this manual carefully to become familiar with your system and to get the most out of its many features and options.

Understanding Voice Amplification and its Benefits

without voice amplification

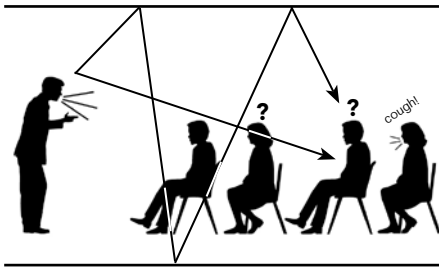

- reduced comprehension
- reduced attention
- teacher fatigue

with voice amplification

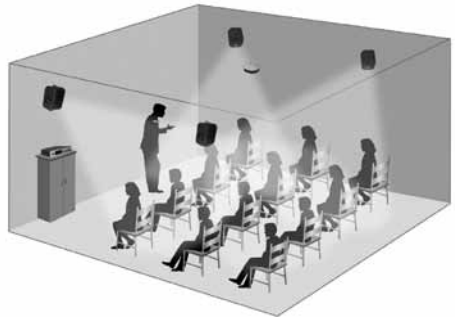

- improved comprehension
- improved attention
- greater teacher energy

Installation Notice

Your FrontRow Symbio system is a precision wireless audio instrument designed to improve students' ability to perceive the teacher's voice.

We strongly recommend having your system set up by a professional installer who is familiar with FrontRow systems (contact your representative for referrals to installers in your area).

If you choose to install your FrontRow Symbio system yourself, take great care to follow the instructions in the *Symbio Installation Guide* found at www.gofrontrow.com/support/product-guides. Achieving the best performance from your system is only possible by properly selecting and positioning sensors. Improper installation can result in poor performance.

Basic System Guidelines

To help ensure that you get the most from this system, follow these basic guidelines:

Microphones:

Proper pendant microphone placement will allow you to comfortably wear your microphone all day and ensure the best sound quality.

Speak at a normal level when using your pendant microphone; the system is projecting your voice for you.

Use a student microphone (sold separately) to create a more dynamic learning environment by amplifying a student's voice when they are reading or presenting.

Do not use two microphones on the same channel. Your FrontRow Symbio receiver is designed to accept audio from two microphones simultaneously, but they must be on separate channels.

Batteries:

Install batteries in your equipment now, then charge overnight before initial use.

Charge microphone batteries every night. Our Nickel Metal Hydride (NiMH) batteries last the entire school day between charges, but should be charged every night so they are ready to go in the morning.

Replace microphone rechargeable batteries after 12 months of use to avoid poor performance and possible equipment damage. Only use special "silver sleeve", auto-sensing batteries supplied by FrontRow.

Avoid battery corrosion. Charge then remove batteries if your transmitter will not be used for several weeks.

Alkaline batteries may be used if you forgot to charge your transmitter the night before. NEVER attempt to recharge alkaline batteries. To ensure proper charging, always be sure that only "silver sleeve", auto-sensing batteries are installed.

For installation instructions go to: <http://www.gofrontrow.com/support/product-guides>

1 Receiver Components



Receiver

1. Receiver
2. Infrared ceiling sensor*
3. Receiver power supply
4. Receiver mounting tray (optional)

*Not necessary if FrontRow IR speakers are already installed

2 Microphone Components



(optional items)



Transmitter

1. 940TM pendant microphone
2. Adjustable neck strap
3. (1) AA (LR6) NiMH rechargeable battery ("silver sleeve", auto-sensing)
4. Aux-in audio adaptor cord (3.5mm to 3.5mm)
5. Two unit charger
6. 950C charger (optional)
7. Pass-around microphone (optional)

3 940TM Pendant Microphone

Features

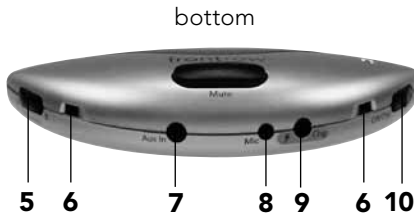
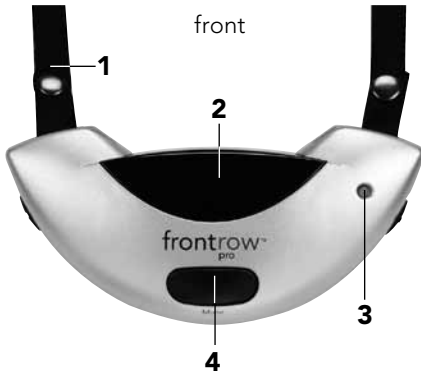

1. Neck strap
2. Infrared emitter diodes
(Do not block)
3. Indicator light
4. Mute button
(Push to mute)
5. Channel selector
(Select Channel A or Channel B. Do not have two microphones on the same channel in the same room)
6. Dual microphone ports
(Do not block)
7. Aux-in audio jack
(Use aux-in audio adaptor cord to send audio from a secondary audio source such as an MP3 player, portable radio/ CD/tape player to the receiver)
8. External microphone jack (optional)
(to connect a boom microphone)
9. Charge jack
10. On/off switch
11. Battery compartment
Accepts 1 AA (LR6) battery
NiMH rechargeable recommended
("silver sleeve", auto-sensing)

4 940TM Pendant Microphone

Installing Batteries and Charging



Your microphone is equipped with SmartCharge technology to protect against charging incompatible batteries. The microphone will only charge the "silver-sleeve", auto-sensing battery that comes with your microphone. If an incompatible battery is detected, the microphone will not let you charge the battery.

Install Battery

1. Push down on tab to open battery compartment
2. Insert battery into compartment. Note polarity indicators
3. Replace battery door
4. Charge battery overnight before initial use

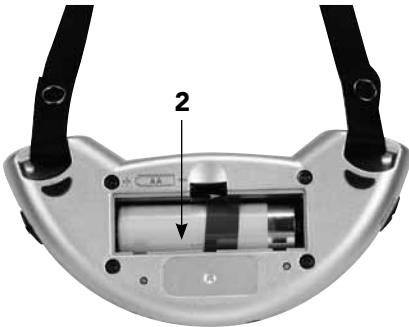

IMPORTANT! To ensure best performance, and avoid equipment damage, FrontRow recommends replacing rechargeable batteries at the beginning of each school year. Do not use batteries that have been dropped or are otherwise damaged.

940TM Pendant Microphone

Installing Batteries and Charging (cont.)



Charge Battery Nightly

1. Microphone indicator light will blink red when battery is low
2. Plug the two-microphone charge cord into the wall
3. **Turn microphone off**
4. Insert any one of the two charge cord plugs into the charge jack
5. The microphone indicator light should be red when charging. If it is **OFF**, check microphone battery and ensure charge cord is properly connected to microphone and plugged in

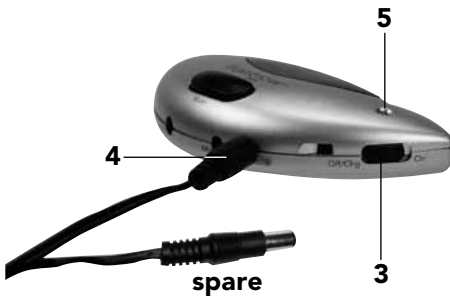

NOTE: If you forget to charge your microphone at night, you may use a standard AA (LR6) alkaline battery instead. Remember to remove the alkaline battery and replace it with a "silver-sleeve", auto-sensing battery before charging the unit.

IMPORTANT! In order to prevent damage to your microphone, the SmartCharge feature is intended to prevent charging of any battery other than the "silver sleeve" auto-sensing battery supplied by FrontRow. Do not attempt to charge alkaline batteries. To ensure proper charging, always be sure that only "silver sleeve" auto-sensing batteries are installed.

940TM Pendant Microphone

Charging with the 950C charger (optional)



1. **Turn microphone off**
2. Place microphone face up into the charge pocket. Ensure it is fully seated.
3. The charger indicator light should be solid red when charging. If it is **blinking red**, you are attempting to charge an alkaline battery or the battery is damaged or worn out. Replace this battery with a FrontRow "silver sleeve" NiMH cell. If the light is off, ensure charger is properly connected to power supply and that you are charging a 940TM microphone (930TM microphones cannot be charged in this charger). Re-check the seating.
4. The charger indicator light will turn green when charging is complete.

NOTE: If the charger is blinking red and the cell is the proper type, make sure the charger contacts are free of contaminants. If they appear dirty, then clean with rubbing alcohol, using a cotton swab.

5 940TM Pendant Microphone

Using

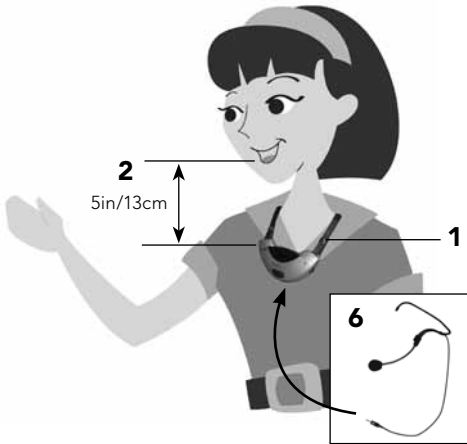

1. Place microphone around neck and connect clasp
2. Adjust neck straps to position microphone as close to mouth as possible (approximately 5in/13cm)
3. Set channel to A or B (whichever is not already in use)
4. Turn microphone on. Indicator light should be green
5. Press mute switch as needed for private conversations. Indicator light will blink green
6. **Optional:** if desired, plug in external boom microphone

Light Legend

- Green On
- Blinking Green Muted
- Blinking Red Low Battery

When Charging:

- Off Alkaline Battery Detected, or microphone power is still on
- Red Charging

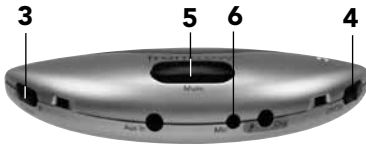

940TM (bottom)

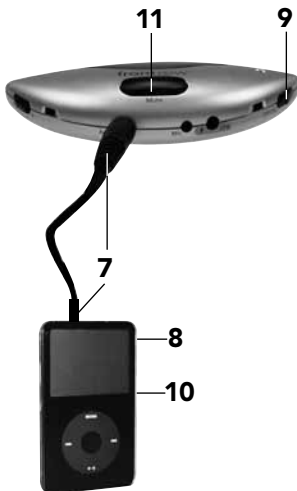

The 940TM Pendant Microphone can be used to transmit audio from a secondary audio source (MP3 player, computer, portable radio/CD/tape player) to the receiver.

7. Plug one end of the audio adaptor cord (included) in the **Audio Out/headphone jack** of the secondary audio source. Plug the other end of the adaptor cord to the **Aux-In** jack on the 940TM Pendant Microphone
8. Turn the secondary audio source on
9. Turn the 940TM Pendant Microphone on
10. Turn the volume on the secondary audio source all the way up and adjust the microphone volume on the receiver to obtain the optimal volume
11. You can "talk over" the secondary audio by speaking into the microphone or mute the microphone to ensure the best audio sound quality

6 950H Pass-Around Microphone (optional)

Features



1. Emitter diodes
(Do not block)
2. 2-way indicator light
Green = On and transmitting
Blinking red = Low battery
Red = Charging via 3.5mm charge
input jack only
No light = Charging via 950C charger
3. On/off switch
4. Battery compartment
(On back)
5. Gain switch
(Inside battery compartment)
6. Channel switch
(Inside battery compartment)
7. Name plate
8. Charge input jack
(Use with 2-unit charge cord only)
9. Aux input jack, stereo summing
10. Lavalier clip
11. 950C charger contacts

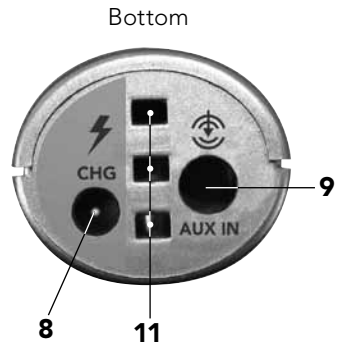
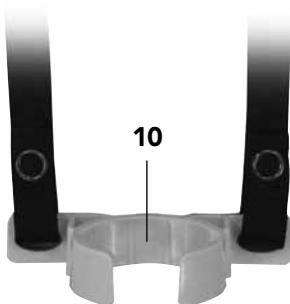

7 950H Pass-Around Microphone (optional)

Setting gain, channel, installing battery, and charging

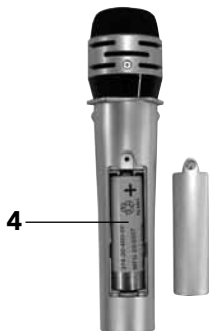

Set gain and channel, and install battery

1. Unscrew battery door to open battery compartment
2. Set gain as follows:
High: If majority of users will hold the microphone far from the mouth
Mid (recommended): For most uses
Low: If majority of users will hold the microphone close to the mouth
3. Set channel to A or B (Whichever is not in use)
4. Insert battery into compartment. Note polarity indicators
5. Replace battery door
6. Charge battery overnight before initial use

IMPORTANT! To ensure top performance and avoid equipment damage, FrontRow recommends replacing rechargeable batteries at the beginning of each school year. Do not use batteries that have been dropped or are otherwise damaged.

Charge Battery Nightly

Indicator light will blink red when battery is low

NOTE: If you forget to charge your microphone at night, you may use a standard AA (LR6) alkaline battery instead. Remember to remove the alkaline battery and replace it with a FrontRow "silver-sleeve", auto-sensing battery before charging the unit.

IMPORTANT! In order to prevent damage to your microphone, the SmartCharge feature is intended to prevent charging of any battery other than the "silver sleeve" auto-sensing battery supplied by FrontRow. Do not attempt to charge alkaline batteries separately. To ensure proper charging, always be sure that only FrontRow "silver sleeve" auto-sensing batteries are installed.

950H Pass-Around Microphone (optional)

Charging with the 2-unit charge cord



1. Plug the two-microphone charge cord into the wall
2. **Turn microphone off**
3. Insert one of the charge cord plugs into the charge jack
4. The microphone indicator light should be red when charging. If it is **OFF**, ensure that you are not attempting to change an alkaline battery, and that charge cord is properly connected to microphone and wall and 950H is **OFF**.

Charging with the 950C charger

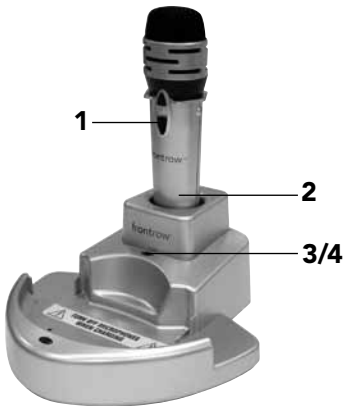

1. **Turn microphone off**
2. Place microphone into the charge pocket. Ensure it is fully seated.
3. The charger indicator light should be solid red when charging. If the light is off, ensure charger is properly connected to power supply and that you are not attempting to charge an alkaline battery.
4. The charger indicator light will turn green when charging is complete and unit will enter maintenance mode.

8 950H Pass-Around Microphone (optional)

Using

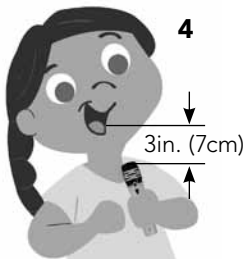
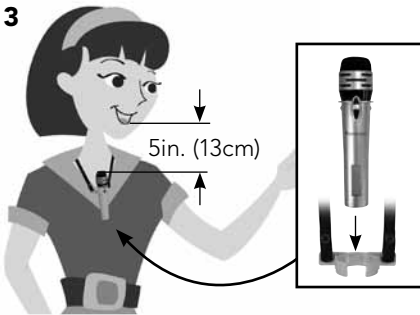
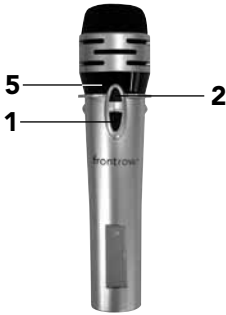

1. Turn microphone on
2. Note indicator light
Green = On and transmitting
Blinking red = Low battery
3. To allow hands-free use (for example, when reading aloud and turning pages), attach the lavalier clip. Adjust neck strap to position microphone approximately 4 - 5in (10 - 13cm) from mouth.
4. Keep top of microphone approximately 3 - 4in. (7.5 - 10cm) from mouth
5. Do not block emitter diodes
6. Turn off microphone and place microphone in charger at the end of the day

NOTE: The 950H is factory set on Channel B.
If you are using two microphones, they must be on different channels.

CAUTION: The lavalier clip should easily slide on and snap into place. Do NOT snap the clip around the body or install the microphone backward or damage may result.

950H Pass-Around Microphone

Using (cont.)



The 950H Pass-Around Microphone can be used to transmit audio from a secondary audio source (MP3 player, computer, portable radio/CD/tape player) to the receiver.

7. Plug one end of the audio adaptor cord (included) in the **Audio Out/headphone jack** of the secondary audio source. Plug the other end of the adaptor cord to the **Aux-In** jack on the 950H Pass-Around Microphone
8. Turn the secondary audio source on
9. Turn the 950H Pass-Around Microphone on
10. Turn the volume on the secondary audio source all the way up and adjust the microphone volume on the receiver to obtain the optimal volume
11. When using this feature the microphone audio is disabled

9 Using a Second Microphone

Classroom 1



teacher 1
(channel A)



teacher 2
(channel B)

Your receiver is designed to receive two microphone signals at once. For example, two teachers (or a teacher and an aide) may each use a microphone. Or, one teacher can use a microphone and students can use a pass-around microphone.

Microphones must be on different channels or interference will occur. **Do not have both microphones on the same channel.**

Classroom 2



teacher
(channel A)



student
(channel B)

10 950C Charger (optional)

Features



1. Charge pocket for 950H Pass-Around microphone
2. 2-way indicator light for 950H Pass-Around microphone
No light = Pocket empty or improper battery
Red = Charging
Blinking red = Charge error
Green = Charging complete
3. Charge pocket for 940TM Pendant microphone (will not charge 930TM pendant microphone)
4. 2-way indicator light for 940TM Pendant microphone
No light = Pocket empty
Red = Charging
Blinking red = Charge error or improper battery
Green = Charging complete
5. Power supply input

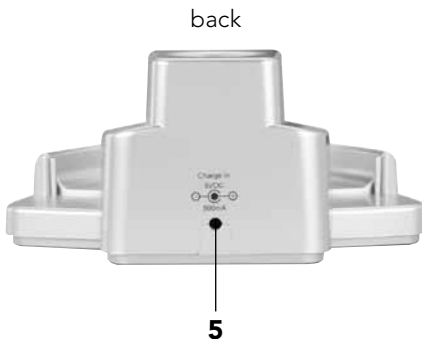

11 950C Charger Setup

1. Plug power supply into power outlet and into the back of the charging base
2. **Charging multiple microphones**

You can charge up to **3 microphones** in any configuration by connecting two chargers to the power supply. **Charging 4 or more microphones will cause the power supply to shut off.**

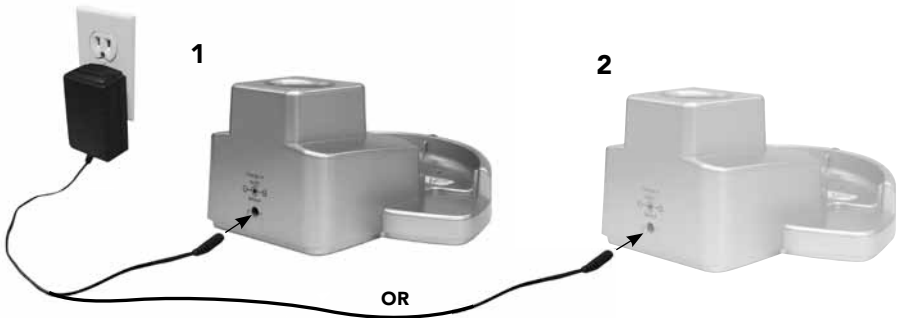

OR

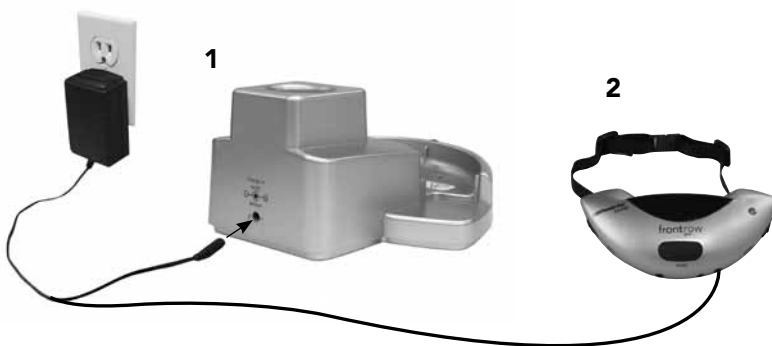

12 5201R Symbio Receiver

Features

front



back

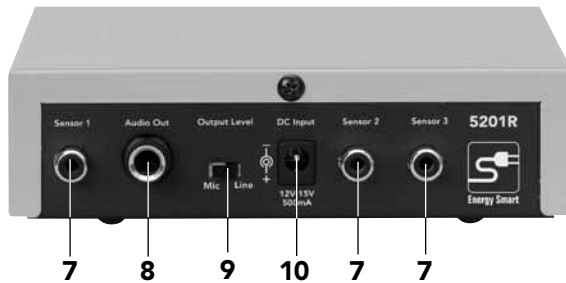

1. Power/Standby Button
2. Microphone A Volume Control
3. Microphone A Reception Light
4. Power On Ready Indicator Light
5. Microphone B Reception Light
6. Microphone B Volume Control
7. Infrared Sensor Inputs (Wall or Ceiling)
8. Audio Out Jack
9. Audio Out Mic/Line Switch
10. DC Input Jack

13 5201R Symbio Receiver

Activate Receiver and Transmitter

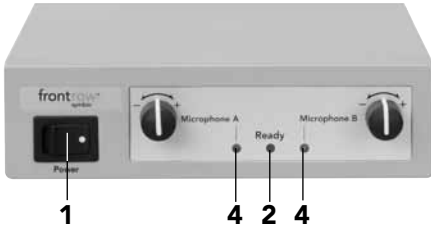

1. Press power button
2. Green..... Power On
3. Put microphone around neck and adjust strap so it is 5in. (13cm) from your mouth
4. Turn microphone on and check microphone A or B indicator light
Green..... Receiving Signal
Red Microphone Off/Muted
5. Speak in a normal conversational tone while walking the entire room. Have a second person adjust the volume to a comfortable level.

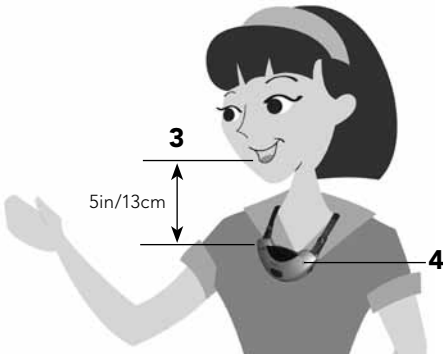

Once the microphone volume is set to the optimal level, the only thing you need to remember is to turn the receiver and microphone on in the morning and turn them off and charge the microphone in the evening.

14 Product Specifications

Symbio Receiver: 5201R



Receiver frequency: 2.3MHz & 2.8MHz
(2 simultaneous channels)

Operating range: 18.5m/60ft line-of-sight
(typical)

Frequency Response: 50Hz to 10kHz

THD: < 1% @ 1kHz

Signal to Noise: > 65dB (system)

Power Supply: 15V @ 600mA

Mic level out: 0V to 100mVrms at maximum
volume & maximum deviation, typical

Line level out: 0V to 1Vrms at maximum
volume & maximum deviation, typical

Size (wxhxd): 14 x 3.8 x 18 cm/5.5 x 1.5 x 7 in

Weight: 766g/1.7lbs.

Pendant Mic Transmitter: 940TM



Transmitting frequency: 2.3MHz & 2.8MHz
(switchable)

Transmission type: Infrared

Operating range: 18.5m/60ft line-of-sight
(typical)

Transmission angles: 160° horizontally;
40° vertically (1/2 power)

Microphones: dual uni-directional cardioid
(directivity index 6.0@500Hz)

Use controls: On/off/mute/channel

Inputs/outputs: 2.5mm mic input; 3.5mm aux
input; 1.3mm DC charge jack

Battery life: minimum 8 hour (single AA,
2500mAH rechargeable NiMH)

Size (wxhxd): 11 x 6 x 2.5 cm/4.5 x 2.5 x 0.9 in

Weight: 85g/3.0oz (with battery)

15 Troubleshooting

Receiver won't turn on (power light doesn't turn on)

- Verify that the power supply is plugged into both the receiver and a working wall outlet

'Dead spots' or microphone crackling/noise

- Verify that you are not blocking either the emitters on the microphone or the sensors mounted around the room
- If reception is interrupted or noisy when facing a certain direction, install an additional sensor in that area of the room (see *Installer Guide*)
- If using more than one microphone, verify that they are not on the same channel
- Recharge or replace the microphone batteries

No signal reception (channel indicator light on receiver is red)

- Check that the microphone is on
- Check that the microphone is not muted (940TM only)
- Verify that you are not blocking either the emitters on the microphone or the sensors mounted around the room
- If reception is interrupted when facing a certain direction, install an additional sensor in that area of the room (see *Installer Guide*)
- If using more than one microphone, verify that they are not on the same channel
- Recharge or replace the microphone batteries

Feedback (squealing)

- Lower the Microphone A or B Volume control(s) on the receiver
- Make sure that speakers are mounted as close as possible to the ceiling and to the listening area; avoid mounting speakers in the teacher's primary lecture area
- Position the microphone closer to mouth

Weak or no output from speaker(s)

- Increase the Microphone A or B Volume control(s) on the receiver, or audio device
- Position the microphone closer to mouth
- Verify that the speakers have been properly installed

High or low pitched whine or hum coming through speakers

- There may be a ground loop with the system. Install a ground loop isolator on the audio output.
- There may be "noisy" electrical wiring. Install an AC line filter

Distorted/gurgling/buzzing

- Microphones are on same channel. If you are using two microphones, set one to channel A and the other to channel B

16 Regulatory

receiver: part 15, subpart B

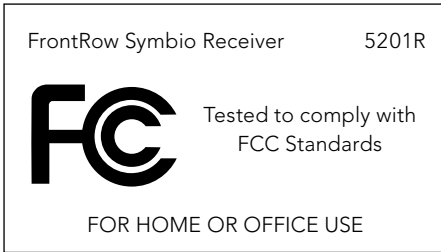

This equipment has been tested and found to comply with the limits for a Class B digital device, pursuant to Part 15 of the FCC Rules. These limits are designed to provide reasonable protection against harmful interference in a residential installation. This equipment generates, uses and can radiate radio frequency energy and, if not installed and used in accordance with the instructions, may cause harmful interference to radio communications. However, there is no guarantee that interference will not occur in a particular installation.

FCC notes

The FrontRow Symbio system is approved by the FCC (Federal Communications Commission). The use of the system may be governed by specific FCC rules and FCC licensing or notifications may be required. Consult your local FCC office for detailed information.

Phonic Ear receivers and transmitters, when required, are approved by the Federal Communications Commission (FCC) in the U.S. and Industry Canada. Other government approvals are available upon request. (Other international regulations may also apply.)

Any changes or modifications made to any government-approved element of this instrument, without the express approval of Phonic Ear, Inc. in writing, could void the user's authority to operate those elements of the system.

 This product conforms with the essential requirements of European Union Directive /EU Directive 2004/108/EC EMC Directive and 2002/95 ROHS Directive. This product can be subject to interference at our operational frequency bands of 2.3 and 2.8 MHz, including harmonics, intermediate frequencies, and images thereof.



Electrical and electronic equipment (EEE) contains materials, components and substances, that could be dangerous or detrimental to human health and the environment if waste electrical and electronic equipment (WEEE) is not disposed of correctly. Products marked with the crossed-out dustbin shown here are electrical and electronic equipment. The crossed-out dustbin indicates that waste electrical and electronic equipment may not be disposed of with unsorted household waste and that it must be collected separately.

In developing and manufacturing your Phonic Ear product, we used high-quality materials and components that can be reused. Thus, when disposing of your waste electrical and electronic equipment, you must use a collection system designated for this purpose, regardless of whether you dispose of your waste at your local waste site or it is collected from your home. Please contact your local authority for further information.

IC notes

This Class B digital apparatus complies with Canadian ICES-003.

Cet appareil numérique de la classe B est conforme à la norme NMB-003 du Canada.

The term "IC:" before the radio certification number only signifies that Industry of Canada technical specifications were met.

frontrow™

USA/Global

FrontRow
Corporate Headquarters
2080 Lakeville Highway
Petaluma, CA 94954-6713
toll-free: 800.227.0735
tel: 707.769.1110
fax: 707.769.9624
web: www.gofrontrow.com

Australia

Phonic Ear
12/97 Castlemaine Street
Milton Qld 4064
Australia
freecall: 1 800 PHONIC
fax: 1300 746 642
web: www.gofrontrow.com.au

Canada

FrontRow
6950 Creditview Road, Unit 1
Mississauga, ON L5N 0A6
toll-free: 800.340.9894
tel: 905.461.5300
fax: 905.677.7760
web: www.gofrontrow.com

Scandinavia

Phonic Ear A/S
Kongebakken 9
2765 Smørum
Denmark
tel: +45 3917 7101
fax: +45 3927 7900
web: www.gofrontrow.com
www.phonicear.com

New Zealand

Oticon New Zealand Ltd.
142 Lambton Quay
P.O. Box 9128
Te Aro, Wellington
toll-free: 800 OTICON
toll-free fax: 00800 FAX
OTICON
web: www.oticon.co.nz

United Kingdom

PC Werth Limited
Audiology House
45 Nightingale Lane
London SW12 8SP
tel: 020 8772 2700
web: www.soundfield.info